

# IXMO FITTINGS

Less is more.

Artikel-Nr. 03507/350401 IXMO, englisch, 08/2020



## FOREWORD

# LESS IS MORE.

This describes the basic principle of IXMO in a nutshell. IXMO integrates functionality in such a compact way that it was possible for the design to be very minimalist. Each IXMO solution is based on a thermostat or a single-lever mixer. Multifunctional modules are added in depending on need. Since they are capable of performing multiple tasks simultaneously, the number of visible parts on the wall can be reduced. This provides formerly undreamed-of freedom for planning the shower, bath tub and washbasin. IXMO wasn't just designed from the point of view of users and planners though, but also from that of the installer. That's why IXMO incorporates a variety of innovative features that allow particularly easy and precise installation.

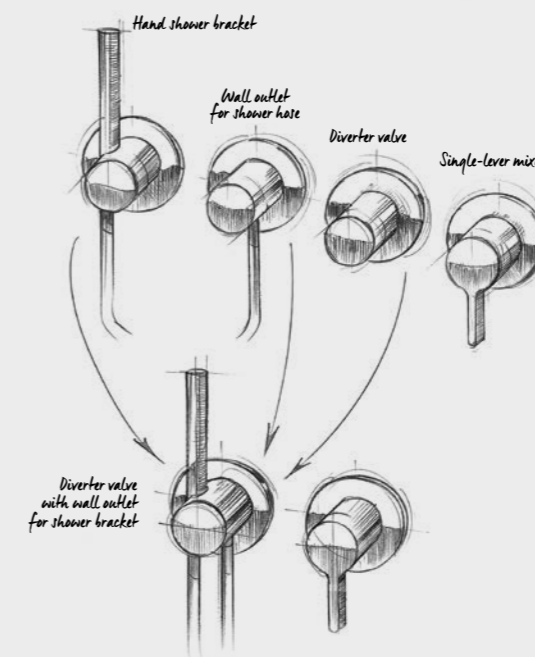

*"This minimalistic approach sets new standards in bathroom design."*

Hartmut Dalheimer,  
Managing Director KEUCO



### IXMO WORLD

Experience minimalistic individuality  
for shower, bath tub and washbasin.

→ [www.keuco.com/gb/ixmo\\_world](http://www.keuco.com/gb/ixmo_world)



# P.6

**IDEA AND DESIGN**  
More consistency



# P.22

**IXMO-PLANNER**  
More variety



# P.10

**IXMO IN SHOWER  
AND BATH TUB**  
More purity



# P.28

**IXMO AT THE WASHBASIN**  
More individuality



# P.14

**IXMO\_solo**  
More reduction



# P.32

**TECHNOLOGY**  
More innovation

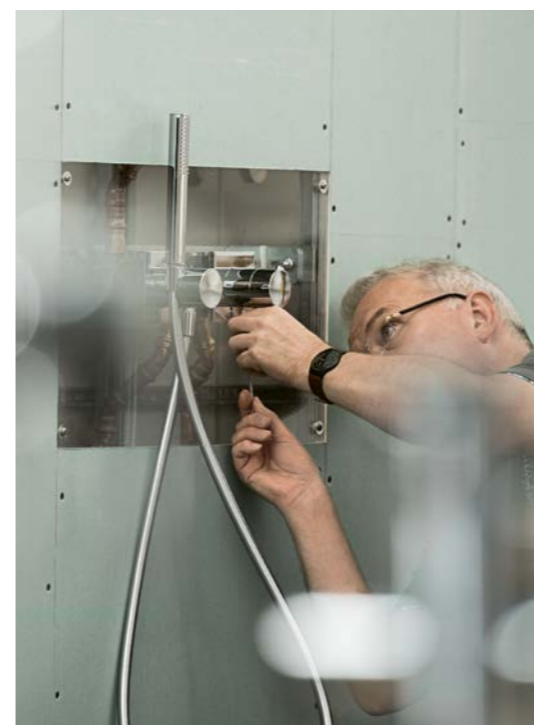

**KEUCO ONLINE**  
Discover fittings for shower, bath  
tub and washbasin that bring  
aesthetic design and sensible  
functionality into harmony.

→ [www.keuco.com/gb](http://www.keuco.com/gb)



## IDEA AND DESIGN

# MINIMALISM MADE IN GERMANY

Throughout the entire development process the abstract idea of “Less is more” or “Less can do more” served as our compass to guide us to that which we today call IXMO. Every technical component is produced and subject to ongoing development in our plant in Hemer. New technology is used to achieve even flatter designs. Ultimately a product is produced that people want to own, because it looks fascinating and offers them new benefits.

IXMO embodies our philosophy perfectly: To create products which are useful, but which offer an experience that touches the senses at the same time. And to do it in perfect quality, to ensure that this lasts a long time. One of KEUCO’s core areas of expertise and decisive factors of success is its own electroplating facilities for surface finishing. Here, flawless surfaces are produced with maximum durability.



KEUCO develops and produces high-end bathroom furnishings at three locations in Germany.

Fittings and accessories are manufactured at our headquarters in the Westphalian city of Hemer – from the design right to the final product.

**93 %** More than 93 % of all KEUCO products are manufactured in Germany.

### COMPANY

Find out more about the KEUCO brand, our tradition and our responsibility.

→ [www.keuco.com/gb/company](http://www.keuco.com/gb/company)

**Left:** Hartmut Dalheimer, Managing Director  
**Right:** Dirk Hagedorn, Manager Marketing and Product Development



*„Combining functions  
together results in  
a completely unique  
design approach.“*

---

Dominik Tesseraux, Designer





# IXMO – MORE PURITY

Design for many styles: The formal minimalism and the clear, geometric lines of IXMO integrate perfectly into a very wide range of furnishing styles. Thanks to the multifunctional nature of the modules, IXMO is the ideal solution for two or three water draw-off points – even in combination with the ROYAL MIDAS light shower.



**MORE SHOWERING COMFORT**  
IXMO fittings for the shower have their origins in our high standard of innovation in the areas of design and technology. By combining three-way stop and diverter valve, wall outlet for shower hose and hand shower bracket in only one module, the number of elements on the wall can be reduced to a minimum.



**MORE BATHROOM DESIGN**  
The high-gloss chrome-plated IXMO bath tub mixers for wall mounting encapsulate wall outlet for shower hose, hand shower bracket, and 2-way diverter valve in a timeless language of form.





IXMO modules can be freely combined as needed: This example brings together thermostat, stop and diverter valve, wall outlet for shower hose and hand shower bracket. Regardless whether round or square decor discs, all IXMO modules are so consistently designed that they perfectly match all other KEUCO lines.





# IXMO\_solo

## LESS CAN DO EVEN MORE

The impressive thing about IXMO\_solo modules is their small dimensions. With only one element needed on the wall, they are the ideal solution for one water draw-off point – and they are also extremely easy to keep clean.

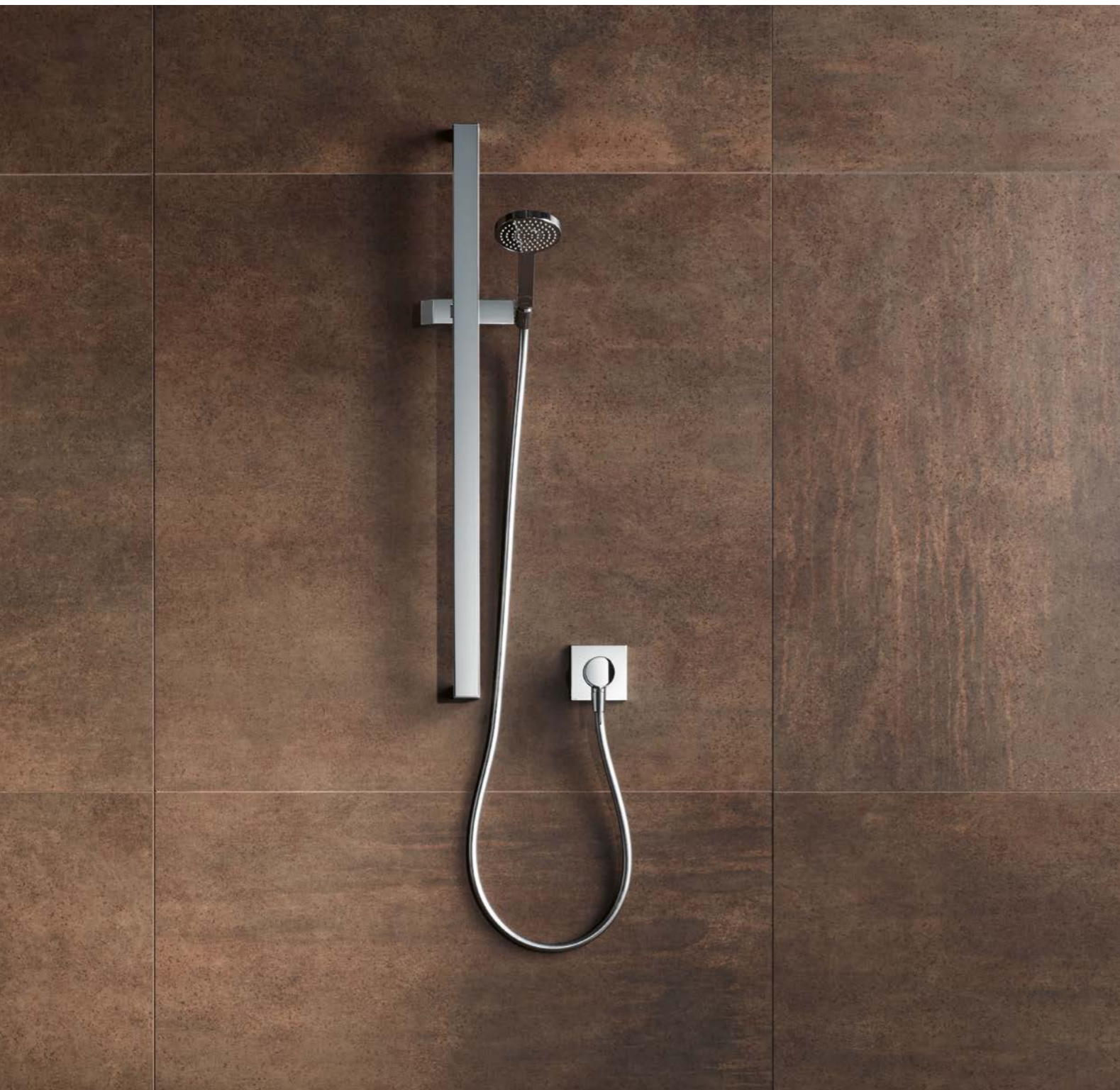

### **IXMO\_solo THERMOSTAT**

IXMO\_solo combines three functions in just one module: For a unique and complete shower solution all that is required is the impressively small, multifunctional IXMO\_solo thermostat and no further water-conducting elements. Operating it is easy and can be grasped intuitively. The water flow is regulated at the front, the temperature at the back. And naturally it also has a 38°C safety stop. The connection for the shower hose is at the bottom.



### **IXMO\_solo SINGLE-LEVER MIXER**

The IXMO\_solo single-lever mixer has even more beneficial features to offer: At any time the water temperature and flow rate can be adjusted to suit your needs. This saves energy and money.





IXMO\_solo thermostat  
with round decor disc



IXMO\_solo single-lever mixer  
with square decor disc





### REDUCTION

In the KEUCO philosophy product design isn't just about aesthetics. The standard itself is holistic: Create a design icon while adding relevant improvements to a product at the same time. With IXMO this succeeds by systematically applying a basic principle: reduction by combining together different functions.



The consistent design can be found throughout a high-quality range of accessories and additional components – each equally convincing in form and function. The special thing about the wall-mounted hand shower bracket is its two locking positions for the hand shower. The practical shelf integrated at the bottom of the hand shower's sliding rail can be swivelled, and is robust enough to bear considerable weight.

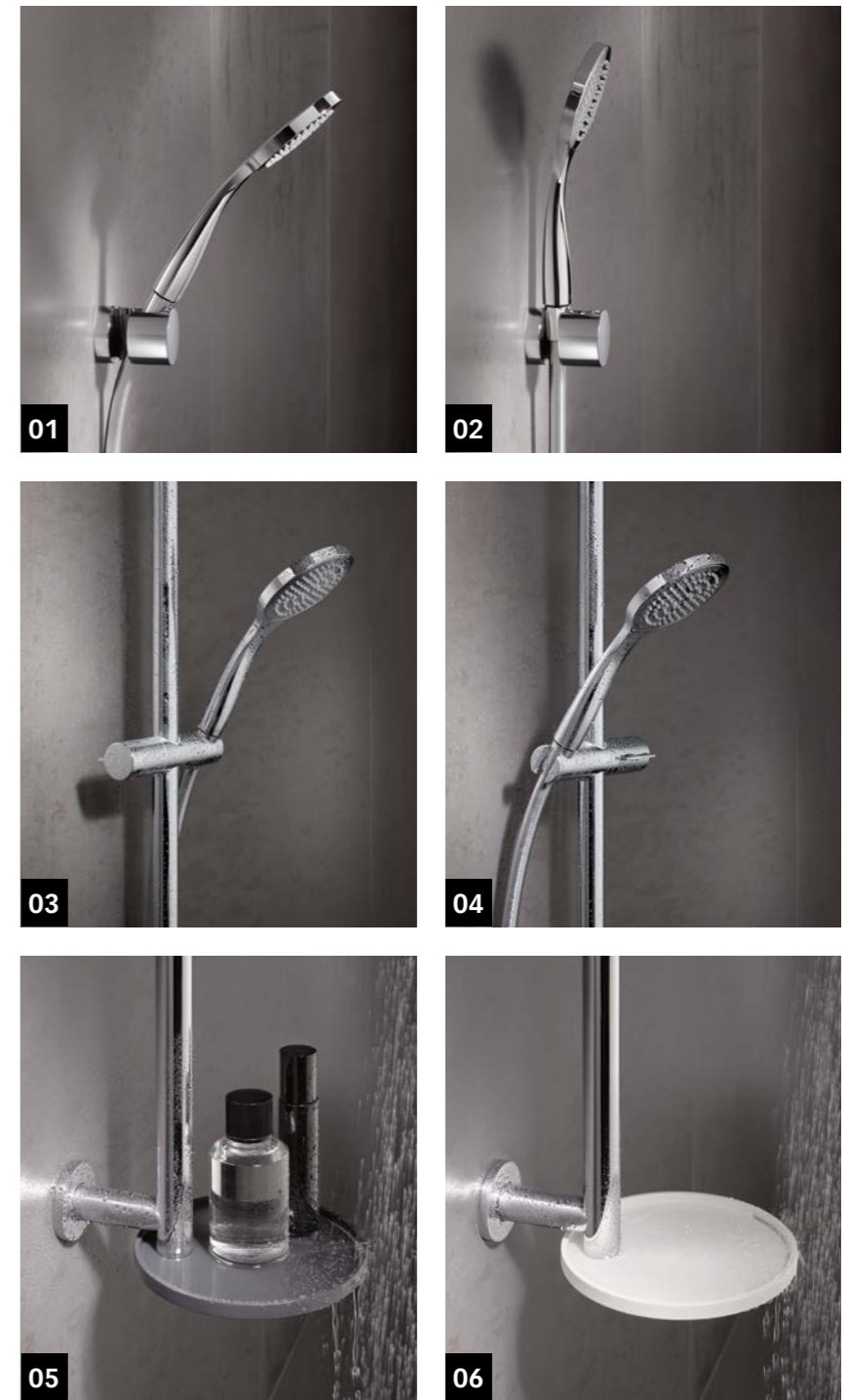

- 01** Wall bracket for hand shower at 60 degree angle, as ideal showering position
- 03** Height-adjustable sliding bracket with spring mechanism
- 05** Swivel shelf, dark grey

- 02** Arranged vertically against the wall, in "parking" position for a tidy look
- 04** Conversion from right-hand to left-hand use
- 06** Swivel shelf, white



*“Through maximum  
planning freedom  
IXMO reflects the trend  
towards simplicity.”*

---

Dirk Hagedorn, Manager Marketing and Product Development





# IXMO-PLANNER MORE VARIETY

Room for possibilities: IXMO permits highly personalised arrangements on the wall. This also incidentally allows optimal ergonomic placement of the modules. Concentrate on the essentials and plan your personal IXMO bathroom now. Your individual result is ready in only a few seconds and can be saved as a PDF, so you can print it out and discuss it with your local specialised dealer right away. → [www.ixmo.de/en](http://www.ixmo.de/en)

## DEVISE YOUR OWN PERSONAL BATHROOM PLAN WITH THE IXMO PLANNER

1. Area of use
2. Control technology
3. Draw-off points
4. Design
5. Handle
6. Surface finish

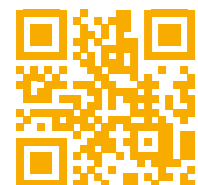

### 1 AREA OF USE

Choose between IXMO modules for shower or bath tub.

Shower  

Bath  

### 2 CONTROL TECHNOLOGY

Choose between single-lever mixer or thermostat.

Single-lever mixer  



Thermostat  



### 3 DRAW-OFF POINTS

Define the type of water outlets.

Hand shower + shower rail  

Head shower  

Spa hose  

Waterfall shower  

Hand shower + wall bracket  



## 4 DESIGN

Choose your design from either round or square decor.

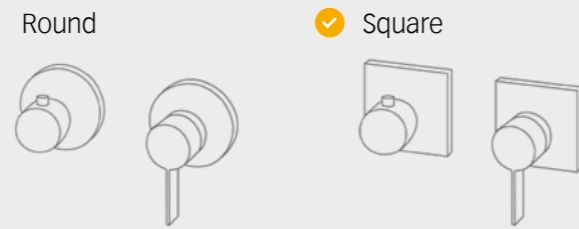

## 5 HANDLE

Define your handle design.

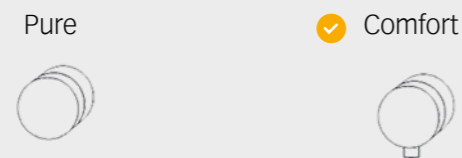

## 6 SURFACE FINISH

You have six extraordinarily elegant surfaces to choose from.

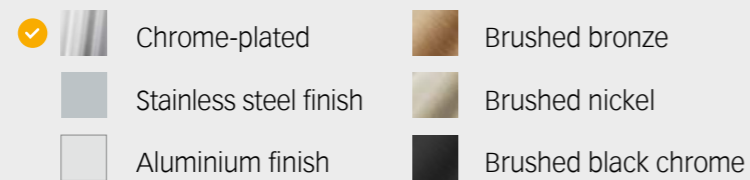

## RESULT

With the IXMO-Planner you can produce a picture of your new shower or bath tub in only a few steps. At the end you receive a complete planning document, including list of materials and other installation aids.

- Article numbers
- Personal summary as PDF
- Installation diagram as PDF
- BIM data



# WELCOME TO IXMO WORLD

Discover fittings for shower, bath tub and washbasin that bring aesthetic design and sensible functionality into harmony. Experience the individuality that variety can produce.

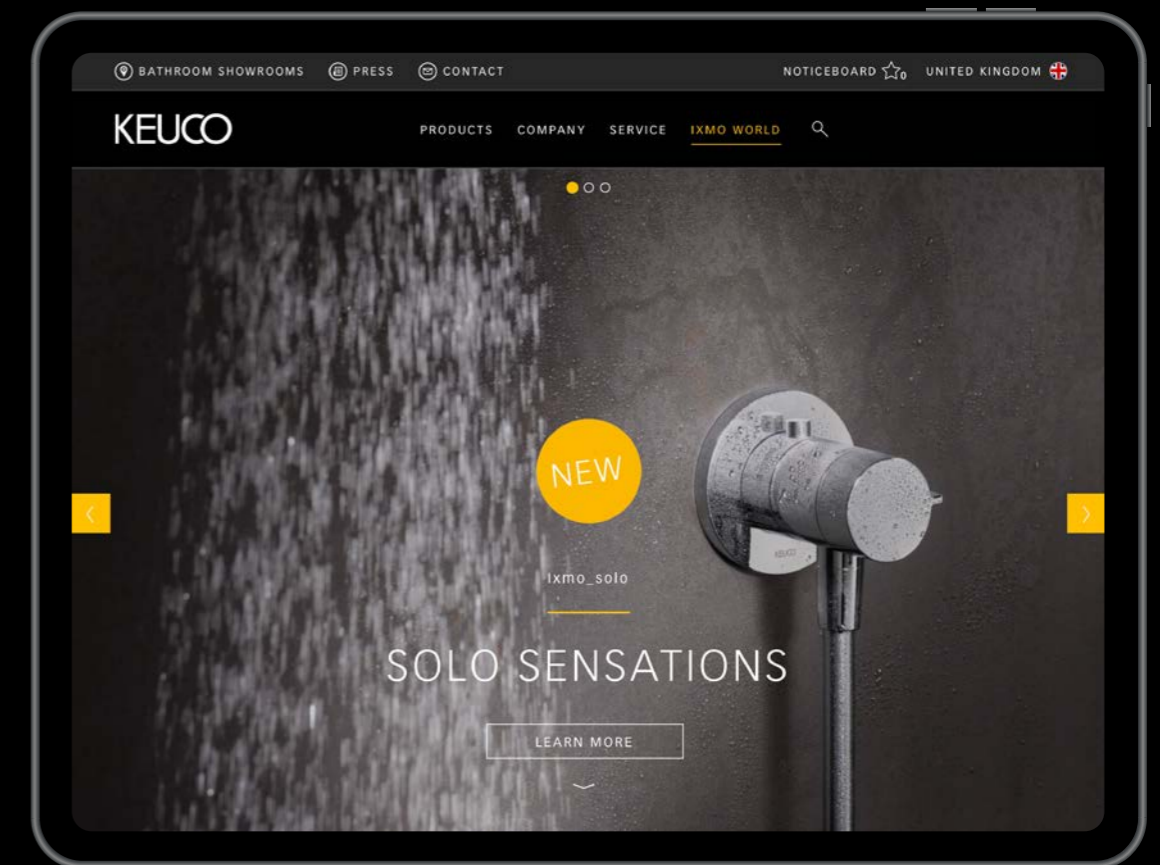

### IXMO WORLD

From inspiration to installation information – discover the diversity of the IXMO world.  
 → [www.keuco.com/gb/ixmo\\_world](http://www.keuco.com/gb/ixmo_world)



*"A central element  
of the bathroom,  
the washbasin is a  
symbol of character."*

---

Hartmut Dalheimer, Managing Director KEUCO







## IXMO AT THE WASHBASIN – MORE INDIVIDUALITY

Extra planning freedom means combining wall spout and single-lever mixer in only one fitting element. The in-wall fitting comes with either round or square decor disc and in three different projection distances from the wall adding a luxurious touch to washbasin design. IXMO: impressive in the shower or bath tub, inspiring at the washbasin.





*“Nothing is as difficult  
as making complexity  
seem simple.”*

---

Christopher Althoff, Product Manager Fittings

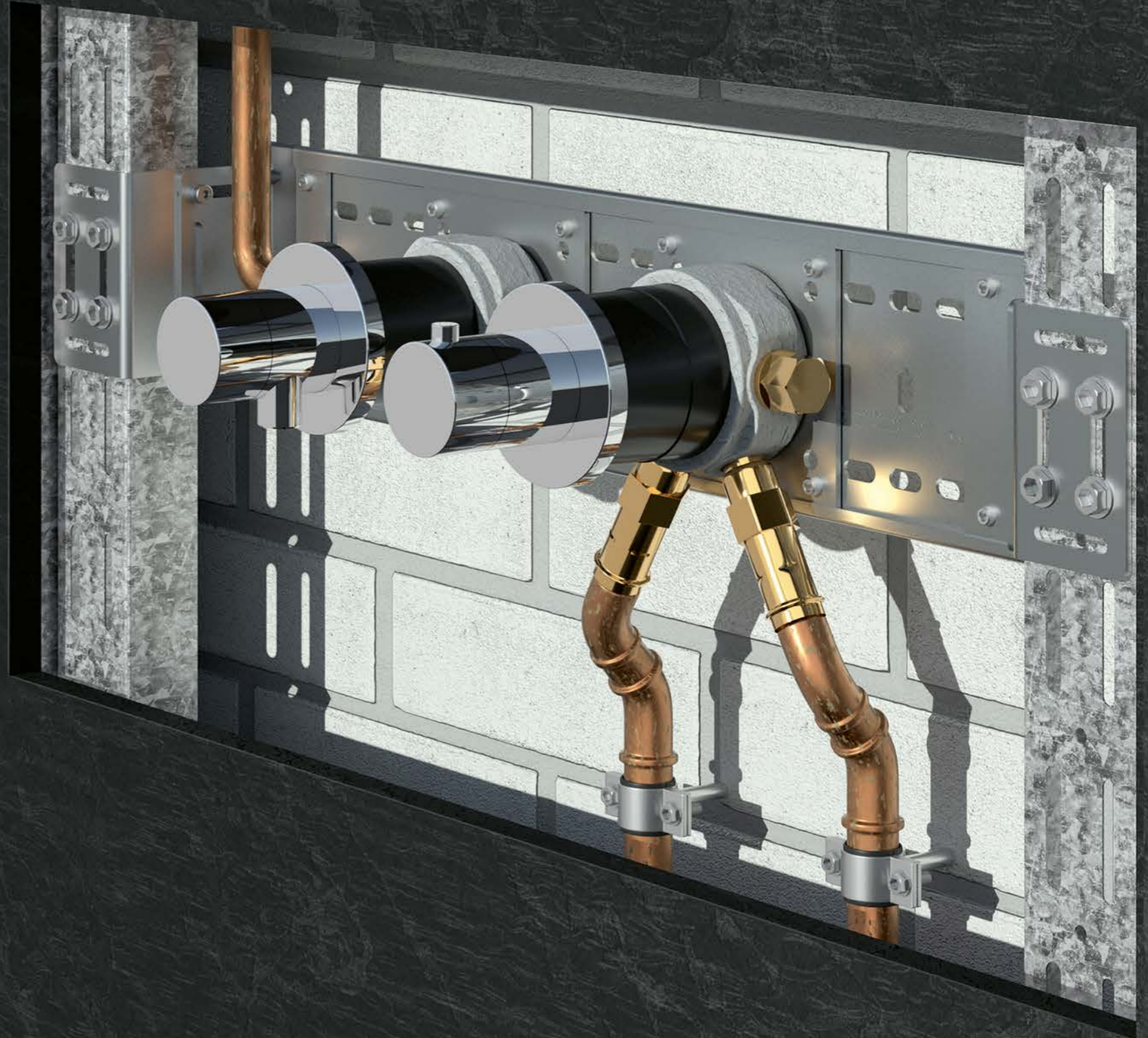



# IXMO – MORE INNOVATION

Functionality redefined: Technically, developing IXMO was a challenge because the combined functions of the modules had to be compressed into the smallest of spaces. This didn't just include the functions the fittings themselves offer, but also all of the innovative features that make them so convenient and reliable to install. Viewed from the outside, it isn't apparent how complex the interiors of the filigree fittings really are.

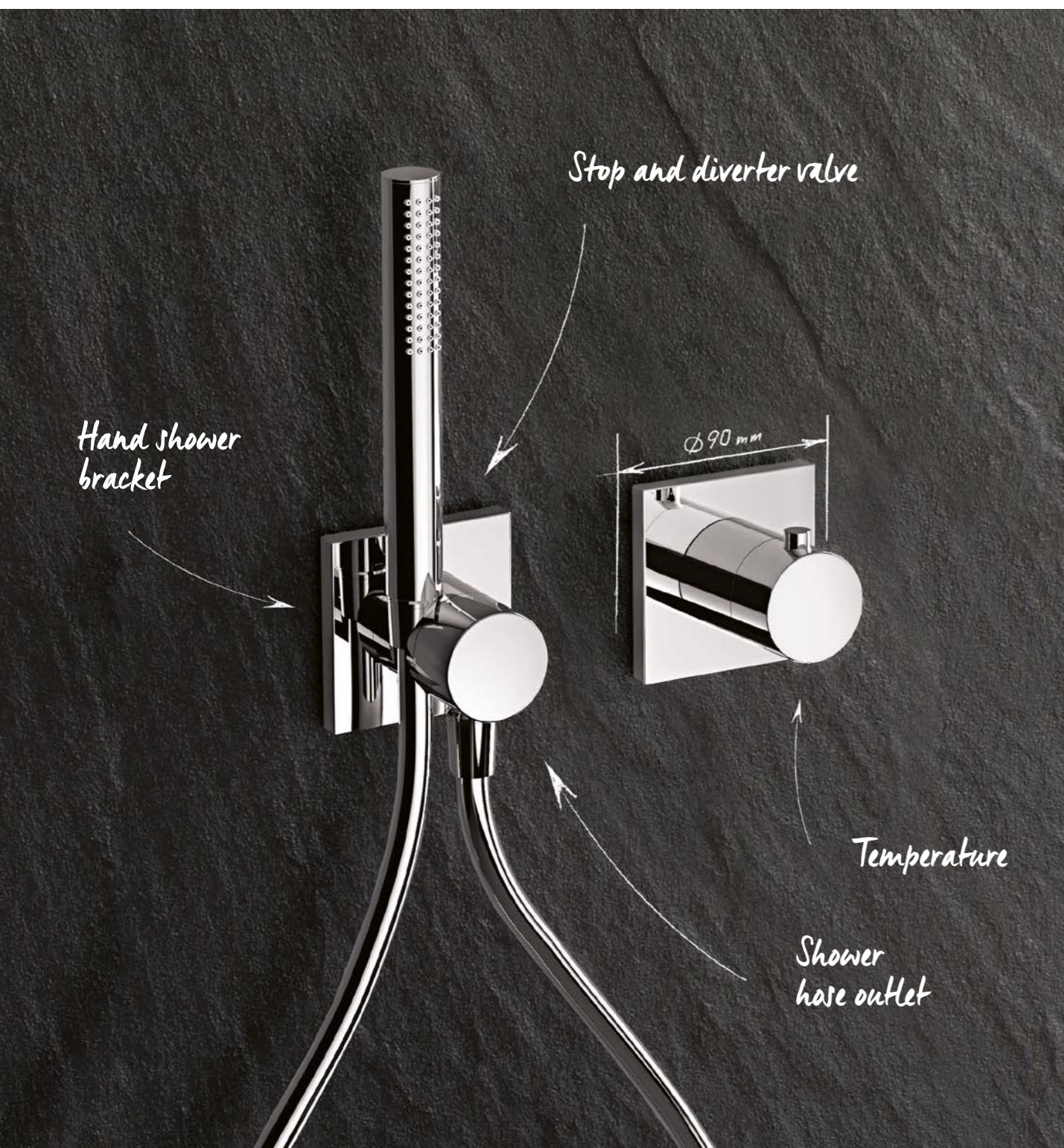

## MORE INTELLIGENT INSTALLATION

The intelligent depth compensator in IXMO fittings can be finely adjusted for installation depths anywhere from 80 to 110 mm. For the single-lever mixer and the thermostat the distance projected out from the wall is always 80 mm.

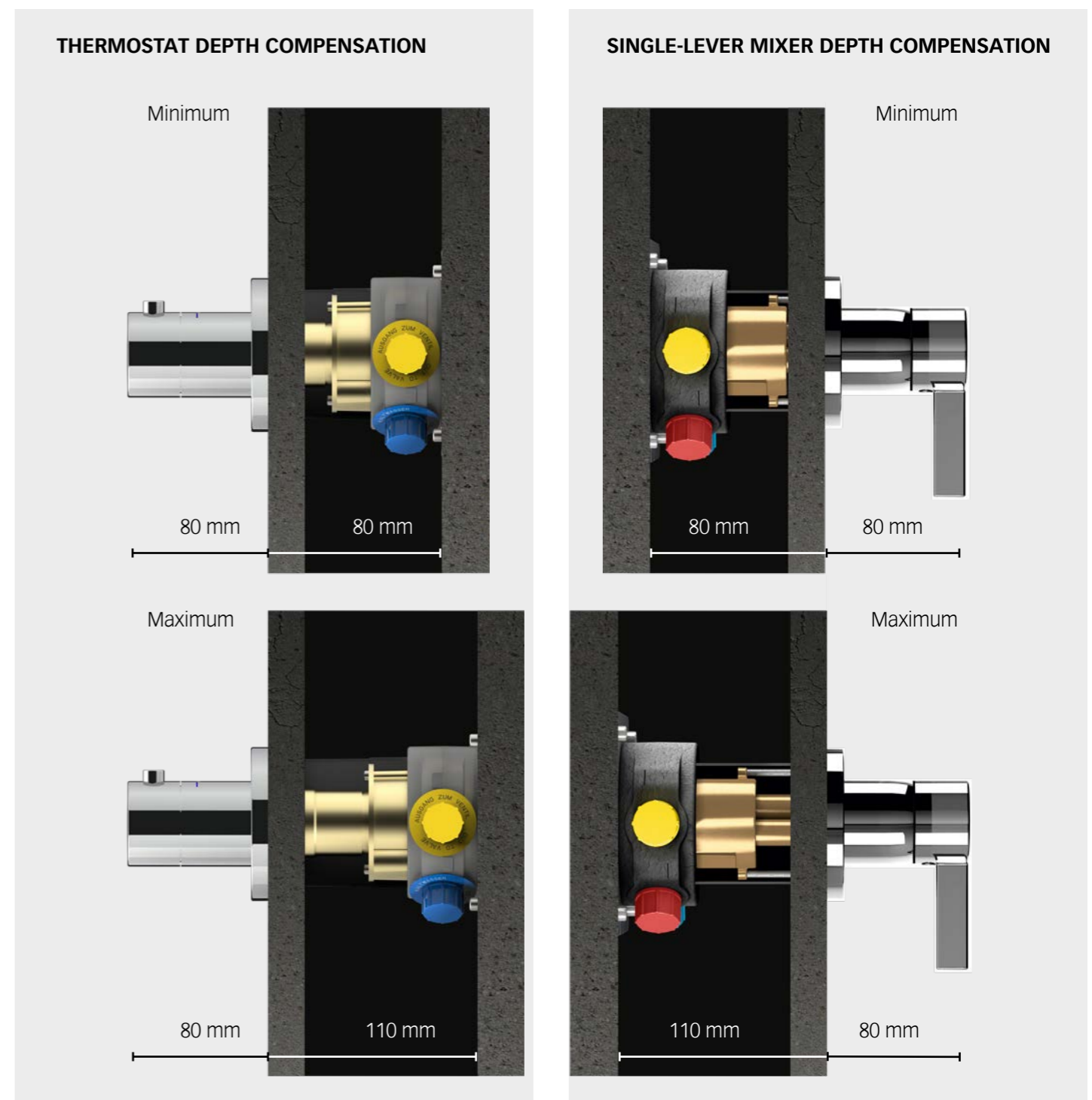



# MORE INSTALLATION ADVANTAGES

A real problem-solver for installers: A special mounting rail is available for IXMO. It can be positioned horizontally or vertically. The installation units can be shifted to any position on the rail and fixed in place with the screws.

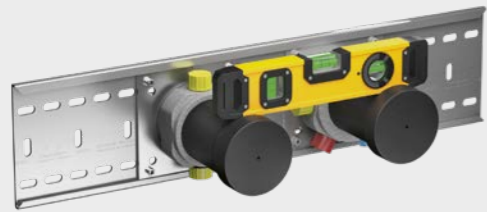

In all modules the temporary plugs have the same diameter, so they can be used for adjustments with a spirit level. If the mounting rail is used, the rail is aligned. The installation units are aligned automatically once they are hung in the rail.

360°



All modules can be flexibly installed in a 360° range, with the exception of the single-lever mixer. The mounting rail can be used in either a horizontal or vertical position.



The temporary plugs have register marks on the front, with the help of which the distance between modules can be precisely measured. On the guide rail the installation units can be shifted by any amount.

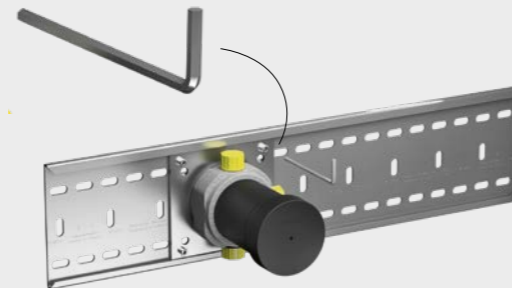

The installation unit can be finely adjusted with the threaded pins in such a way that it is aligned perfectly against the wall at right angles. When the mounting rail is used, the threaded pins are used to fasten the modules to the rail.

## MORE POSSIBILITIES

In cases where the water lines are swapped in the bathroom, no additional adapter needs to be procured. Because, IXMO thermostats have an integrated solution, which allows the assembly groups to be simply swapped in the rough part.

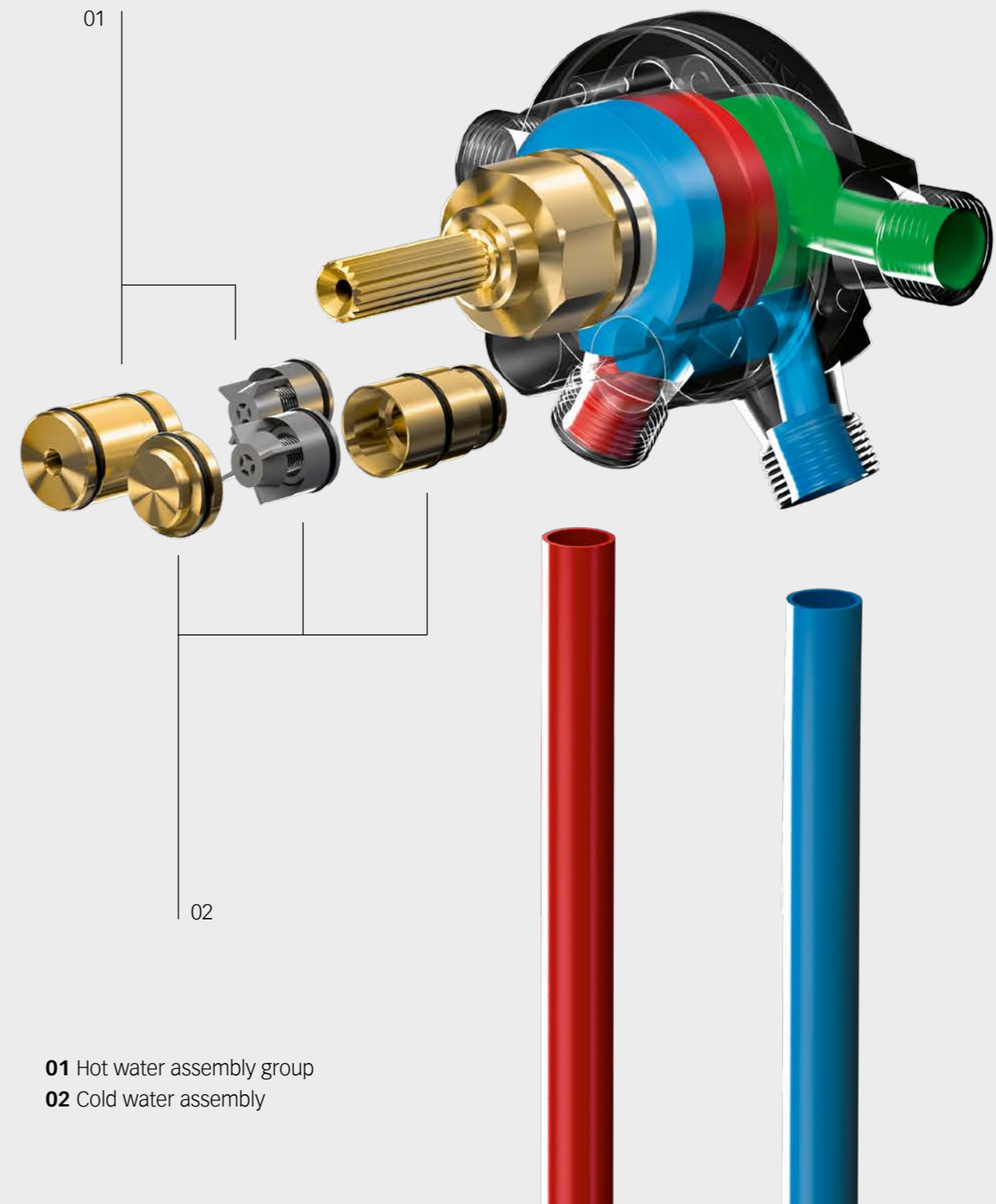

- 01** Hot water assembly group  
**02** Cold water assembly



# IXMO\_solo MORE MINIMALISM

Only one water-conducting element is required on the wall to combine either single-lever mixer or thermostat with the wall outlet for the shower hose: This generates more freedom of design in the bathroom and considerably less installation work. The minimalistic approach of IXMO sets new standards in bathroom design.

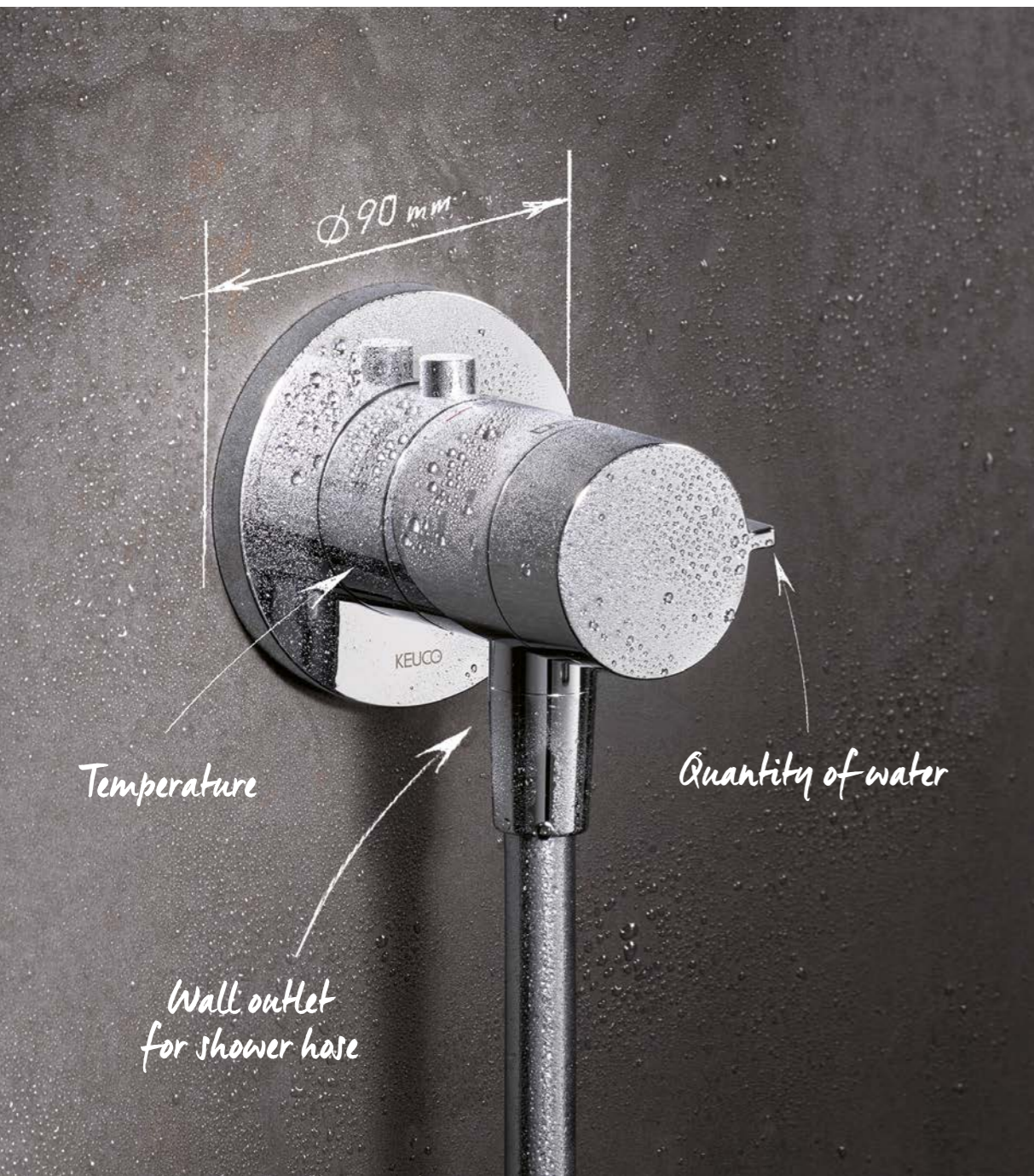

## THERMOSTAT DEPTH COMPENSATION

Minimum



Maximum

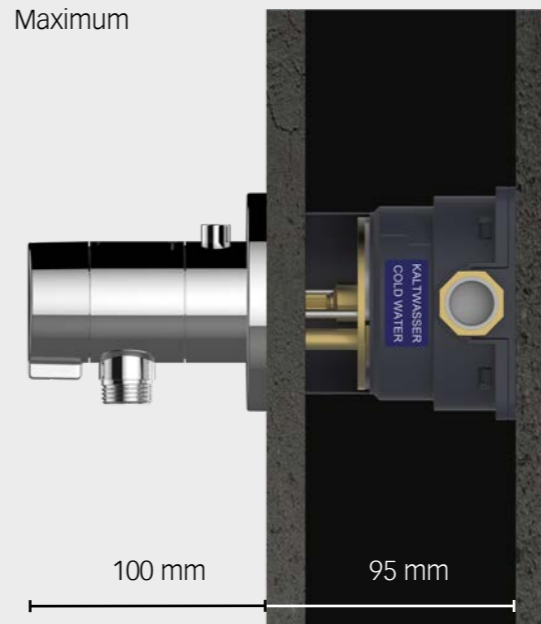

## SINGLE-LEVER MIXER DEPTH COMPENSATION

Minimum



Maximum

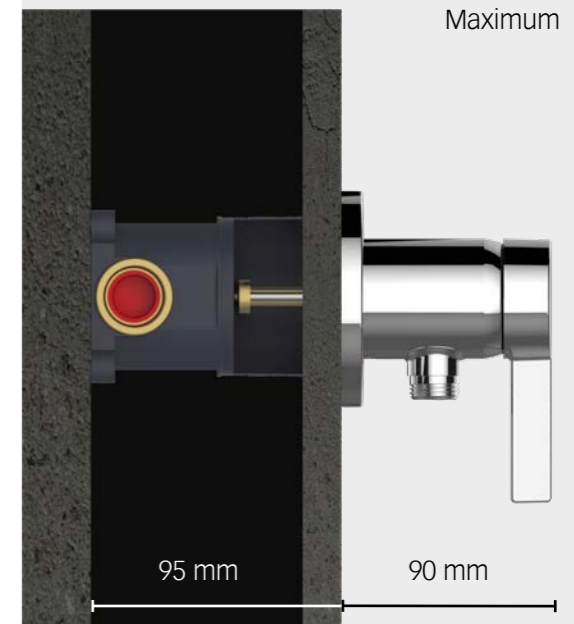

### MORE FUNCTIONALITY

The single-lever mixer projects out from the wall exactly 90 mm and the thermostat 100 mm. The in-wall installation unit can be installed without difficulty in thin walls or during subsequent modernisation work. What makes this possible is the minimum

installation depth of 65 mm. And thanks to the intelligent depth-compensation feature, it can be flexibly adjusted by any amount from 65 to 95 mm. And even swapped water lines can be corrected with an integrated assembly group.



# DISCOVER MORE

Making a difference is what our product developments are all about. The difference can be found in the functionality. Or in the product design. Or better yet, in both – paired with excellent KEUCO quality.



## KEUCO ONLINE

Explore our products and other brochures online.

→ [www.keuco.com/gb](http://www.keuco.com/gb)

The extraordinary surface characteristics and extremely fine colour nuances of our products can only be reproduced to a certain degree in print. Only the original KEUCO products can provide an optimal impression. They can be seen in the showrooms of sanitary trade dealers. Reproduction and copying, even if only excerpts, are only permitted by explicit permission of the manufacturer, and with the inclusion of source information. KEUCO GmbH & Co. KG, PO Box 1365, D-58653 Hemer

We expressly reserve the right to make technical changes for the purpose of improvement, as well as colour and design changes that are deemed necessary. Print errors and omissions excepted.

Concept, design and lithography: Kontrast Communication Services GmbH, Düsseldorf; Text: KEUCO, Kontrast Communication Services GmbH, Düsseldorf; Photography: CASA GmbH & Co. KG, Münster, Stephan Schacher, New York; Druck: Meinders & Elstermann GmbH & Co. KG, Belm, Osnabrück.

